

ALUMINUM RAILING SYSTEMS | SECONDARY HANDRAIL

ARABIAN
Railing Systems
Lifetime Warranty



KEYLINKFENCING.COM

HIGH QUALITY ALUMINUM RAILING

Lifetime
Warranty

THE CHOICE IS SIMPLE

- 1 3/4" Wide Top Rail
- 13 Baluster Options (Includes Glass)
- Self-Centering Mounting Brackets
- 11 Color Options
- Rattle-Free Vinyl Lined System
- Easy to Install
- Boxed Railing Kits Available
- Limited Lifetime Warranty
- AAMA 2604 Rated Powder Coating
- Tested to IRC & IBC Building Codes
- Universal Step Bracket Available
- Manufactured in USA
- Heavy Wall Extruded Aluminum
- Decorative 3 Rail Options Available

Arabian Railing Height Options: **36" and 42"**

Level Railing Length Options: **6' and 8'**

Step/Stair Railing Length Options: **6' and 8' (32°-36°)**

Railing Kits Include: **Top & Bottom Rails, Balusters, Mounting Brackets & Hardware**



BALUSTER STYLE EXAMPLES



Lifetime Warranty

All Arabian™ railing, posts, brackets, and connectors are warranted against failure of either the materials used, or the manufacturing process, for life. This warranty does not include slight changes in coloration due to the natural aging process. It also does not include any damage or failure due to misuse or abuse.

COLOR OPTIONS

STANDARD COLORS



RAILING PROFILES



Top Rail

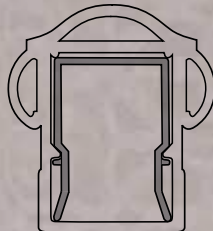

1 3/4" x 1 7/8"

Unique full length PVC inserts in both the top and bottom rails to allow a faster, "screwless" assembly and create a tight, quiet fit.



Bottom Rail

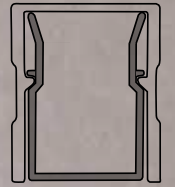

1 1/4" x 1 1/2"

Drains in the bottom rail allow any moisture to escape.

BALUSTER OPTIONS

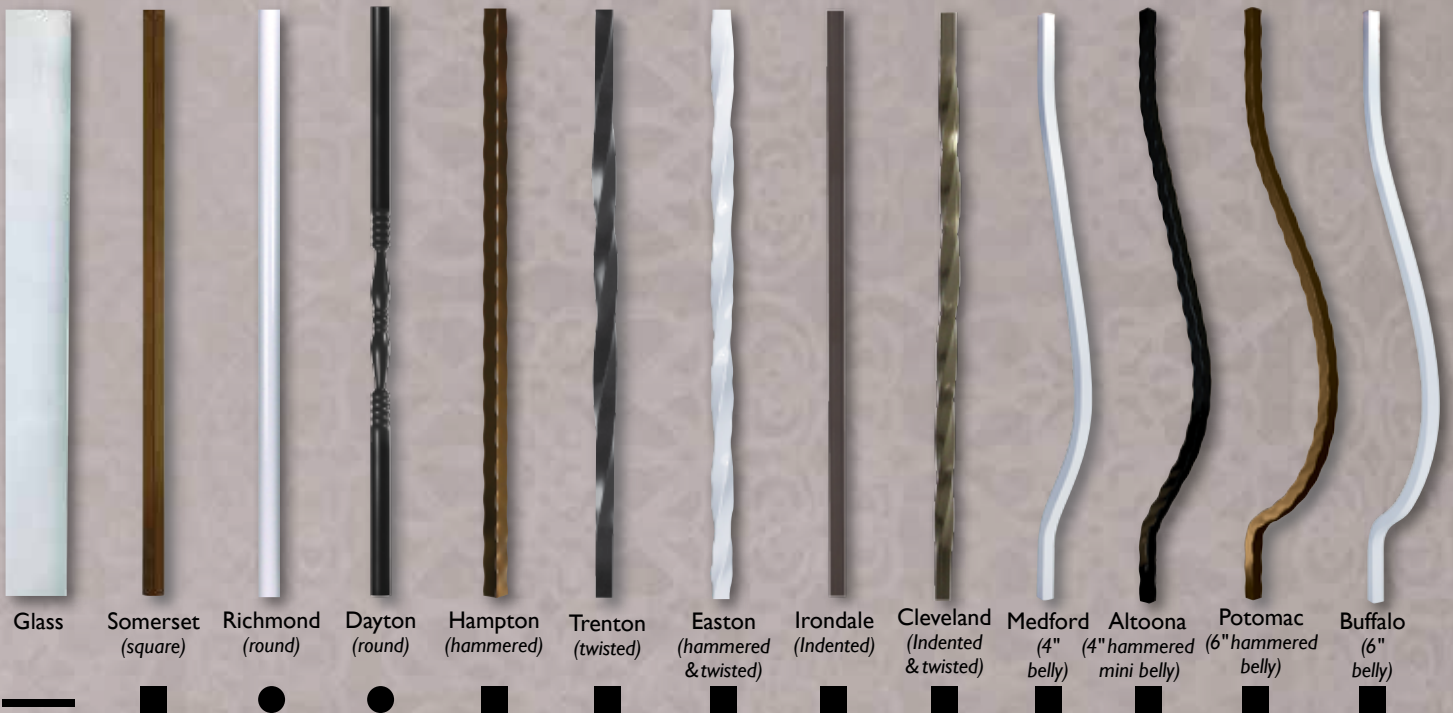

- Glass
- Somerset (square)
- Richmond (round)
- Dayton (round)
- Hampton (hammered)
- Trenton (twisted)
- Easton (hammered & twisted)
- Irondale (Indented)
- Cleveland (Indented & twisted)
- Medford (4" belly)
- Altoona (4" hammered mini belly)
- Potomac (6" hammered belly)
- Buffalo (6" belly)

SOMERSET RAILING



Somerset
(square)



RICHMOND RAILING



Richmond
(round)



Trenton
(twisted)



TRENTON RAILING

Hampton
(hammered)



HAMPTON RAILING

DAYTON RAILING



Dayton
(decorative round)



EASTON RAILING

ALTERNATE
HAMMERED
AND
HAMMERED
TWISTED



Easton
(hammered & twisted)



Available in 6' sections.



Includes railing section support for each section.

GLASS RAILING

Minimum radius 24°



Curved radiuses can be fabricated to your specifications.



CURVED RAILING



POTOMAC RAILING
6" Hammered Belly Picket

ALTOONA RAILING
4" Hammered Belly Picket

MEDFORD RAILING
4" Belly Picket

BUFFALO RAILING
6" Belly Picket

IRONDALE RAILING



Indented Baluster

CLEVELAND RAILING



Twisted & Indented Baluster



3 RAIL OPTION

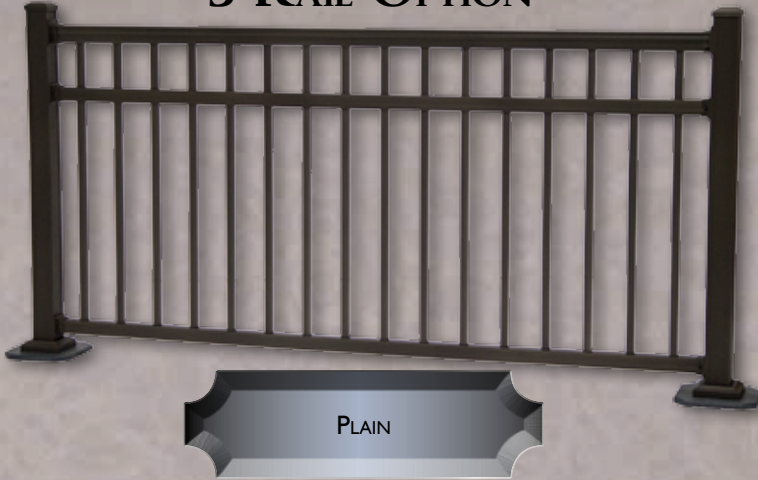

PLAIN

The Arabian 3-Rail System offers a subtle way to bring an architectural design element to your railing project. The balusters go through the routed rail to the top rail. Add rings or butterfly scrolls for a more dramatic look.



WITH BUTTERFLY CENTERPIECE



WITH RINGS

CABLE RAIL

- Available in three standard colors
- Sold in 36" high, six foot sections with no bottom rail
- Includes a 3/4" 39" spacer/stabilizer baluster to be fastened in the center of the section using mounts of a matching color
- The top rail (a pre-drilled center baluster) and the baluster mounts will be boxed together as a kit
- Cable will be sold by the foot
- Pre-drilled 3 1/4" posts will be available
- Posts and center baluster will be pre-drilled by Key-Link at 2.875" between each cable
- Cable hardware will utilize swivel mounts.



The Arabian Series Cable Rail is the perfect complement to any architectural design. It adds a modern and contemporary feel to any building and is an excellent choice for settings with a view.

It lends itself well to any area, residential or commercial, where a contemporary look or a virtually unobstructed view is desired.

The stainless steel cables combined with aluminum post and rail assemblies make for a strong, durable and low-maintenance system that will last for a lifetime.

Stainless steel cable runs through posts with minimal fittings for a sleek, modern look.



**SOLAR LIGHT OR
LOW VOLTAGE LIGHTS**
2½" or 4"



Black or Bronze or White

LAMBS TONGUE



**END POST
ACCENT**



CROSS OVER ADAPTER
Enables standard top rail to be installed on top of newel posts.
Available in 4", 3¼" & 2½"



BALUSTER MOUNTS



Stair

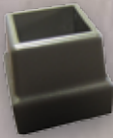

Level



Square mounts fit all balusters except round

POST CAP OPTIONS



Ball
(Optional)



Flat
(Standard)

ALL AVAILABLE IN
2½" • 3¼" • 4"



TRIM RING



**GINGERBREAD
CORNER SCROLL**



**34 DEGREE
ANGLE POST**

Specifically designed to work with ramps. Comes standard with a welded plate.

AVAILABLE IN
2½" • 3¼" • 4"

SPECIAL ORDER
3-Week Lead Time

NEWEL POSTS with a welded 3/8" aluminum plate... can be installed on concrete, wood or composite decking for secure installations.

AVAILABLE IN 2½" • 3¼" • 4"



STRAIGHT TOP & BOTTOM BRACKETS
Set of 4 (2 each)



STEP TOP & BOTTOM BRACKETS
32° - 36°
Set of 4 (2 each)



45° TOP & BOTTOM BRACKET ADAPTORS
Set of 4 (2 each)



HORIZONTAL SWIVEL TOP AND BOTTOM BRACKETS
Set of 4 (2 each)



VERTICAL STAIR SWIVEL MOUNTING BRACKETS

For use when an angle is required in adjusting sections for stairs or slopes.
Set of 4 (2 each)



UNIVERSAL STAIR SWIVEL MOUNTING BRACKETS

For use when an angle of *any degree* is required in adjusting sections for stairs or slopes.
Set of 4 (2 each)

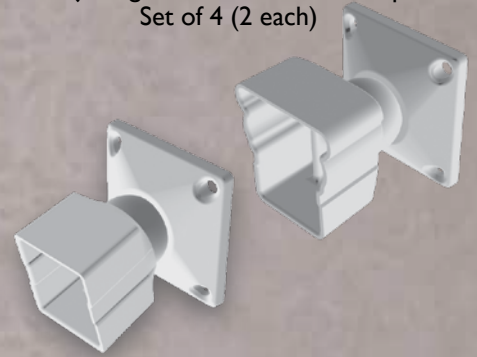

ROUND COLUMN ADAPTOR KIT

For 6"-8" round columns. Used with brackets that are supplied with sections.



22½° TOP AND BOTTOM BRACKETS
Set of 4 (2 each)



RAILING SECTION SUPPORT



SNAP-ON SECTION SUPPORT
Standard with all 8' Sections



UNIVERSAL (ANY DEGREE) STEP BRACKETS
Set of 4



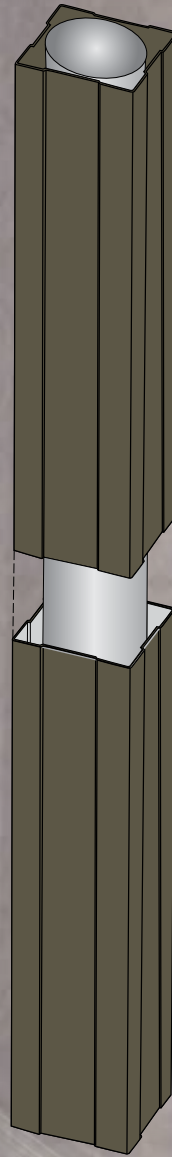

3/4" x 3/4" x 108"

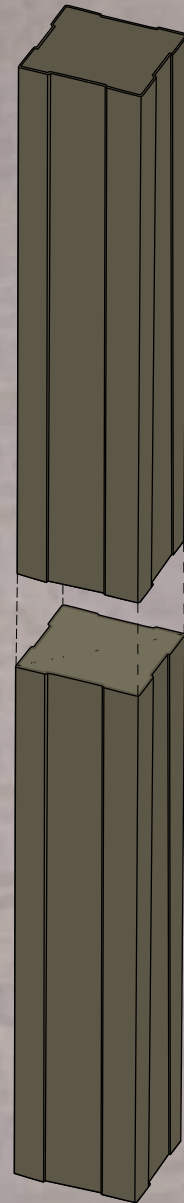

4" x 4" x 108"

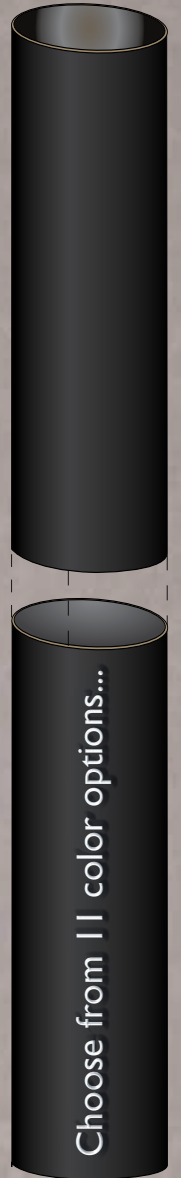

6" x 6" x 108"

Choose from 11 color options...

TRIM RING

All standard colors



ALUMINUM ROUND COLUMN TRIM/MOUNTING BRACKET

7 1/2" x 7 1/2"



MOUNTING BRACKETS

Included with porch posts



3/4"



4"

REGULAR MULTI-ADJUST HINGE
approx. 3¾" high



SELF-CLOSING GATE HINGES
approx. 3¾" high



LOCKABLE GATE LATCH
approx. 6" high



Optional Kit
EXTERNAL ACCESS KIT
Lockable Push-Button operates latch from outside the fence.

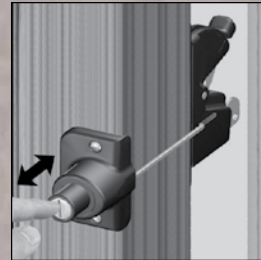

OPTIONAL GATE HANDLE
approx. 5" high



18" & 24" GATE DROP PIN LATCH

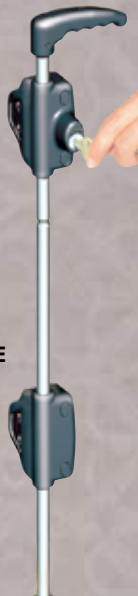

DROP PIN PLATE



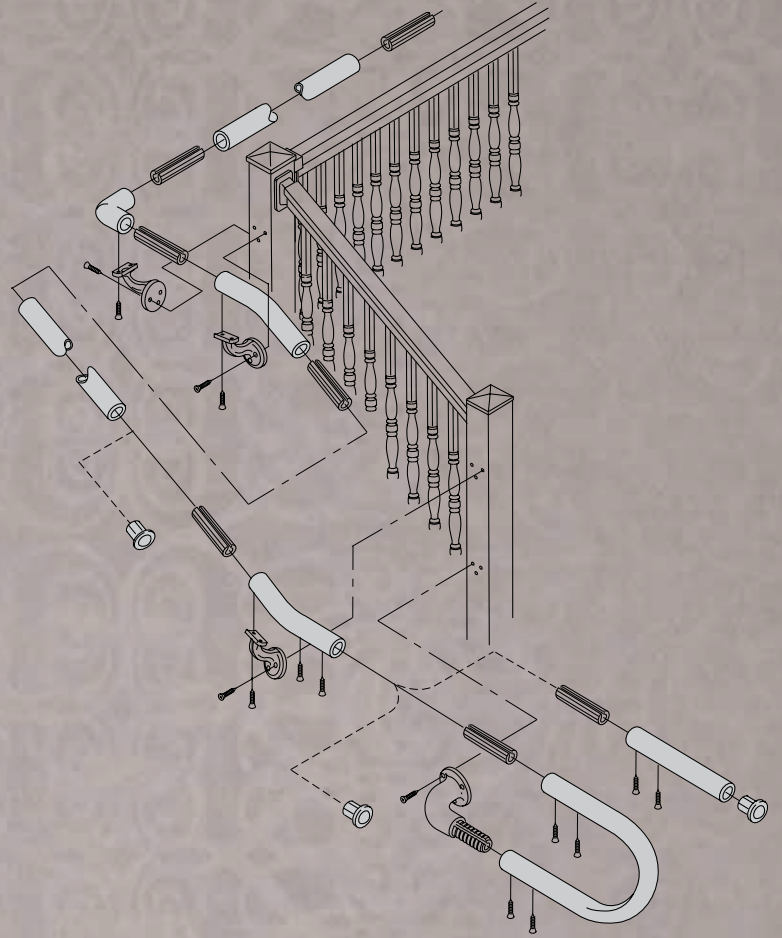

ALL COMPONENTS ARE AVAILABLE FOR ANY INSTALLATION.



1 1/2" STANDARD MOUNTING BRACKET



1 1/2" 90° RETURN BRACKET



5° RADIUS ELBOW

1 1/2" ROUND HANDRAIL 104" LONG



1 1/2" CONNECTOR



34° RADIUS ELBOW

1 1/2" END CAP



1 1/2" OUTSIDE ELBOW

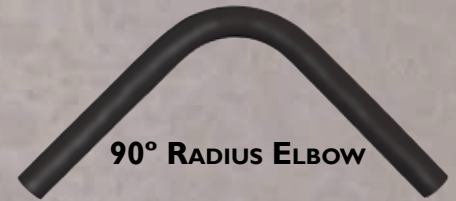

90° RADIUS ELBOW

6" CORNER MOUNTING BRACKET



1 1/2" END WALL MOUNT

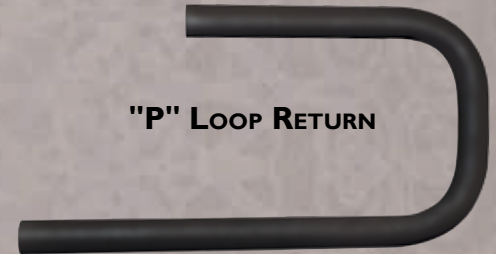

"P" LOOP RETURN

DECORATIVE

2" DECORATIVE HANDRAIL 104" LONG



2" CONNECTOR



2" END CAP



2" STANDARD MOUNTING BRACKET





150 Orlan Road | New Holland, PA 17557



Key-Link
Fencing & Railing, Inc.
KEYLINKFENCING.COM

DEALER:

#Key_Arabian Vers.03-14